



Voltage Range	6 – 12 V
Dynamic Torque	2.0 Nm (@6V) 2.5 Nm (@8.4V) 2.7 Nm (@12V)
Peak Current	5.0 A (@6V) 6.5 A (@8.4V) 5.0 A (@12V)
Peak Speed	400 °/s (@ 6V) 570°/s (@8.4V) 760 °/s (@12V)
Angular Range	± 90 degrees
Temperature Range	-20 to 85°C
Control	333 Hz
Height	38 mm (1.50")
Width	20 mm (0.79")
Length	38 mm (1.50")
Weight	84 g (3.0 oz)
IP Rating	IP65

Benefits

- High-speed control over CAN
- Individually addressable servos with multicast and broadcast addressing supported
- Real-time feedback of multiple parameters
- Internal current measurement with user-configurable limit
- High-frequency switching is gentle on the power supply by reducing voltage drops and current spikes and allows for smooth control
- User-configurable input/output mapping for custom linearization of control surfaces
- User-configurable motion control parameters: bandwidth, velocity limit, acceleration limit (soft start and soft stop)
- Accelerometer data with real-time vibration analysis
- High quality construction with all-metal body and gearing
- Seamless integration with Piccolo, Veronte & Ardupilot autopilots
- Fully documented ICD for integration with third party systems
- PC control software for servo control and configuration
- Full suite of graphing / logging / data analysis tools
- Fault monitoring and analysis
- Servo keeps track of telltale information (CEquip)

Description

The CBS-20 CAN servo (CE1520) is a fully digital servo motion control solution, with advanced control algorithms delivering a high level of performance and reliability.

The CBS-20 servo provides a complete closed-loop actuator system for use in unmanned aerial vehicles. It features a high-frequency current-limiting feedback system, with advanced motion control profiling, which is fully user-configurable.

Servo control is provided over a high-speed CAN connection, fully compatible with the Piccolo, Aurdupilot and Veronte series of autopilots and tightly integrated with the Currawong range of products. With a fully documented command set, it is ready to be integrated into other platforms with a simple protocol specification.

In addition to high-speed control of servo position, the CAN connection provides real-time feedback of servo position, current, temperature and other data at user-configurable rates.

Each servo also features accelerometer-based vibration sensing, which provides a vibration analysis system distributed around the aircraft, with this data available via CAN. Accelerometer data can be sampled at up to 1 kHz for high-resolution vibration data.

A variety of user-configurable warning thresholds (such as current, vibration and position error) provide vital real-time diagnostic information for configuring and monitoring the health of the aircraft.

Dimensions

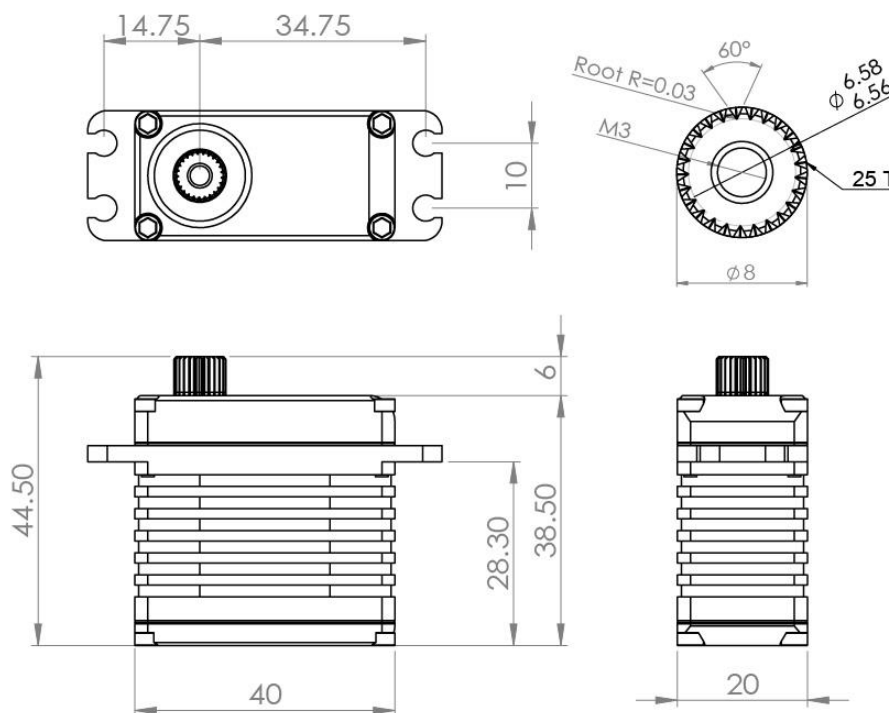

Figure 1: CBS-20 dimensions.

Advanced Motion Control

The CBS-20 CAN servo features an advanced motion controller, which filters the input signal to provide bandwidth limiting and can impose acceleration and speed limits (see Figure 2) on the servo at all times. This allows the servo to behave smoothly and gently on linkages without reducing its capacity to produce high torque if needed.

CEquip

In addition to the servo electronics and firmware, Currawong has developed CEquip, a highly capable software suite. CEquip, functionality includes calibration, testing and monitoring of servo performance, with integrated logging and graphing capabilities. Screenshots of CEquip are shown in Figure 3.

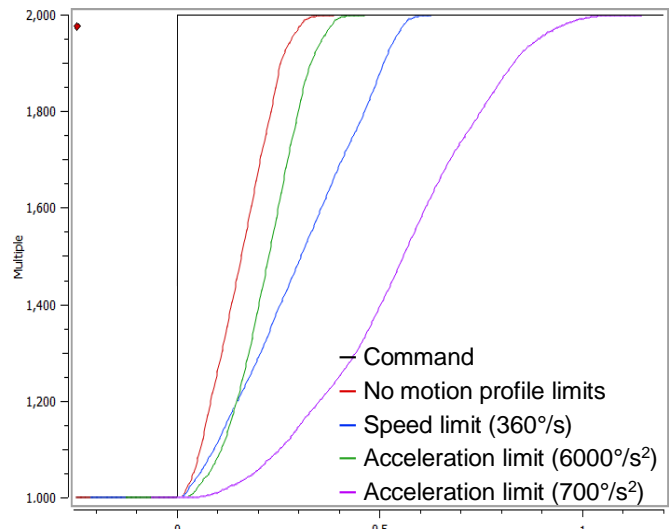

Figure 2: Servo position step response with different motion control profiles.

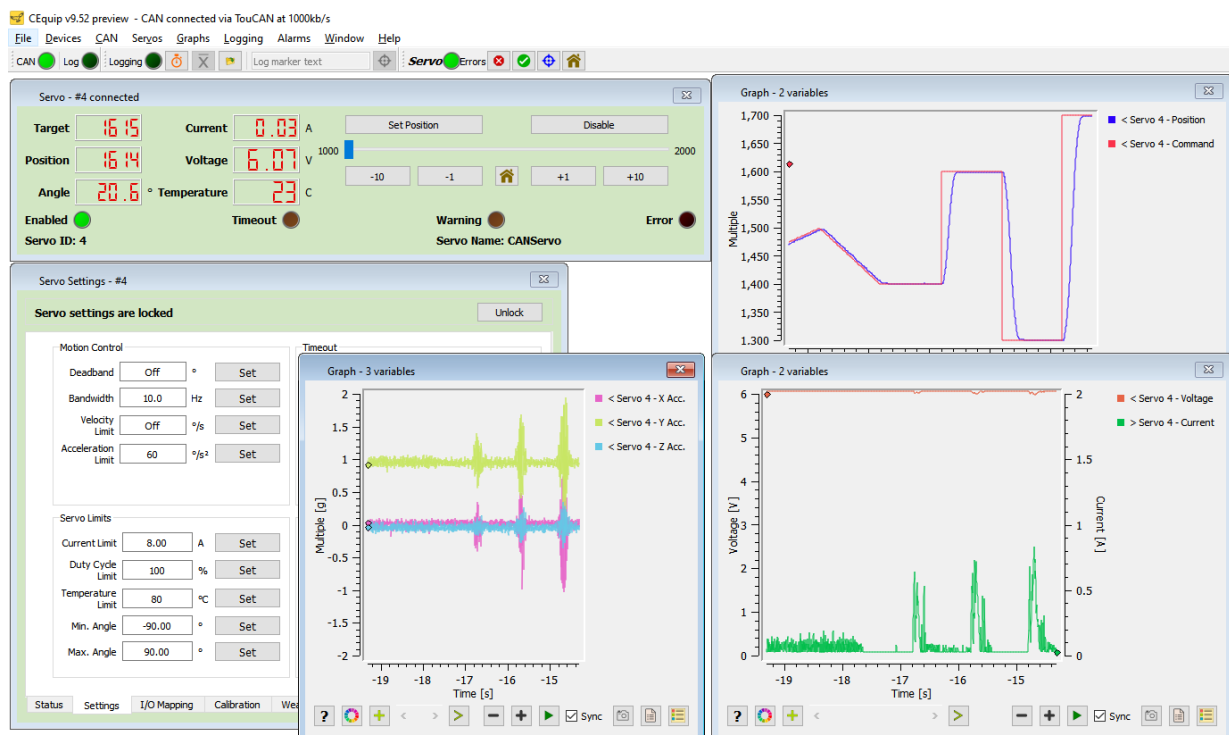

Figure 3: CEquip software showing: servo status, servo settings and graphs of actual position, commanded position, current, voltage and accelerometer data.

Performance Data

The following data are indicative of servo performance under nominal operating conditions.

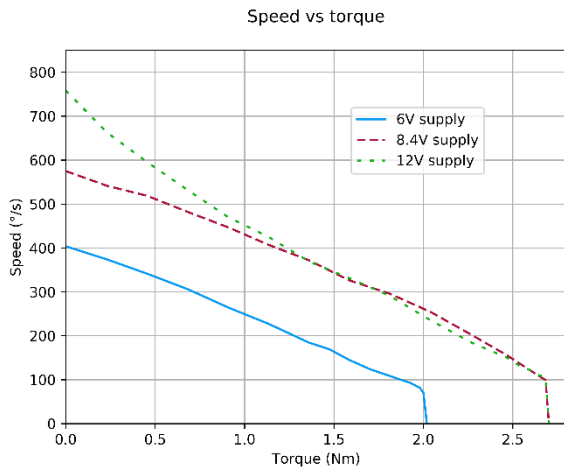

Figure 4: Servo speed vs torque. 'Speed' is peak shaft speed when loaded with the specified torque.

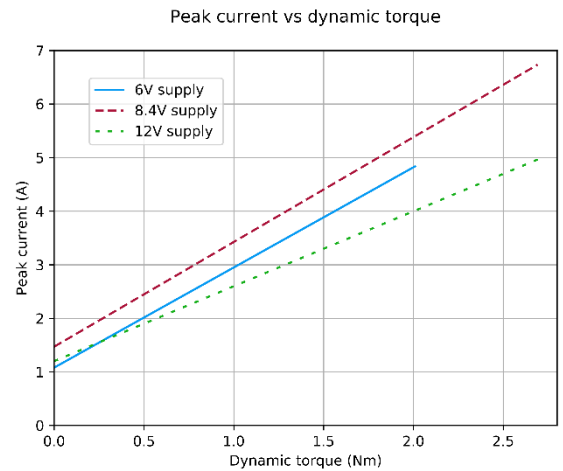

Figure 5: Servo peak current vs dynamic torque. 'Peak current' is measured when the servo is slewing to a new position under load.

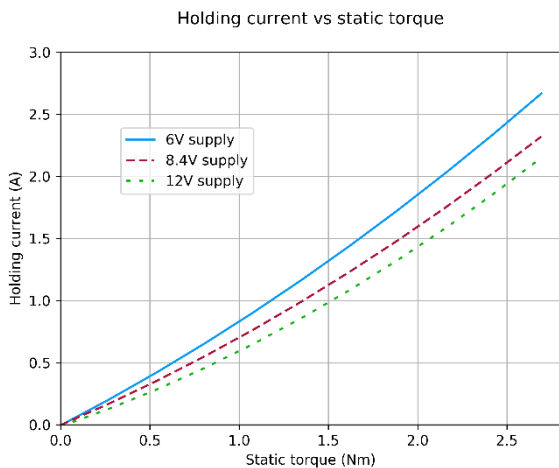

Figure 6: Servo holding current vs static torque. 'Holding current' is measured when the servo is holding position under load.

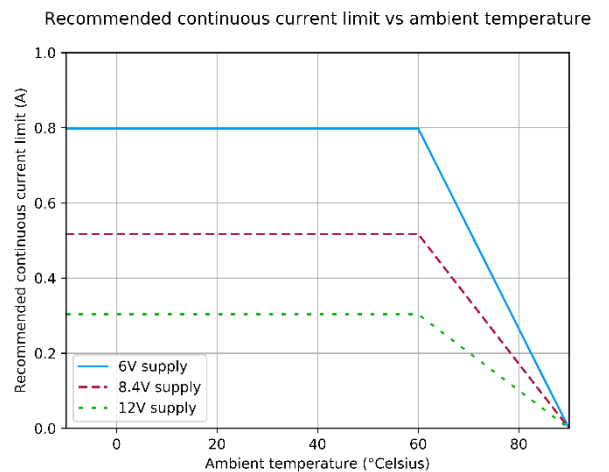
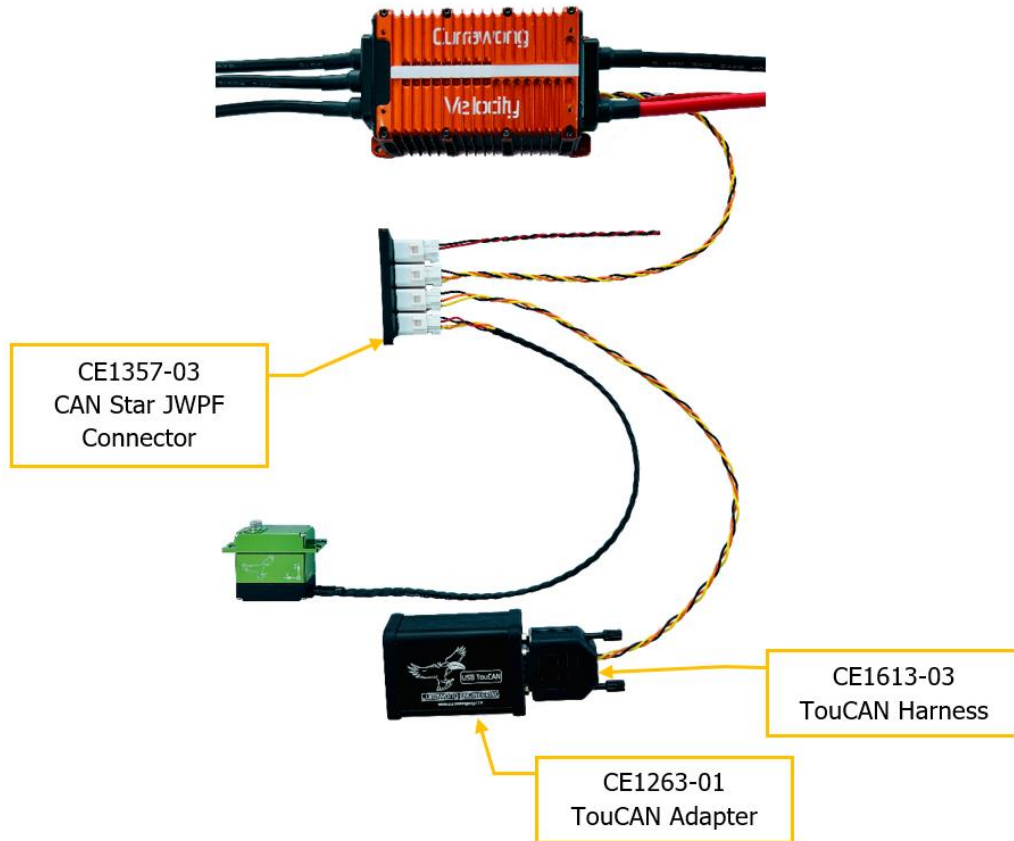

Figure 7: Recommended continuous current limit vs ambient temperature. Servo temperature should remain below 90°C and below 30°C above ambient.

USB to CAN converter kit

In order to perform engineering tests, configure the engine components and update firmware, the following TouCAN USB to CAN converter kit is recommended to new customers comprising:



The TouCAN is a fully electrically isolated USB to CAN adapter for the integration and testing of in-situ CAN devices. The TouCAN provides advanced protection against ground shift and electrical noise, ensuring the safety of the host PC. It also provides optional bus termination for user convenience. Currawong offers a matching harness for the TouCAN.

The CAN Star connector is a simple breakout board providing connection for multiple CAN devices to the bus. It provides power and CAN connections for each device.

The TouCAN is for ground use only.